



DUSCHSYSTEME

SHOWER SYSTEMS



Qualität aus Leidenschaft · Quality built on Passion

 **MWE**[®]
Edelstahlmanufaktur GmbH

EDITION IX

MIT QUALITÄT AUS LEIDENSCHAFT

MWE steht für maximale Verarbeitungsqualität und große Liebe zum Detail. Es ist unsere Philosophie und Aufgabe, Produkte aus Deutschland zu entwickeln, die konsequent dem Zeitgeist entsprechen und dabei Raum für Individualität lassen. Das bedeutet für alle MWE-Mitarbeiter, jederzeit den höchsten Anforderungen hinsichtlich Design, Verarbeitungsqualität und Funktionalität gerecht zu werden.

Das Besondere: Sämtliche Produkte durchlaufen eine komplexe Fertigungsabfolge und zwar zu ca. 100% unter unserem Dach. MWE setzt in der zerspanenden Bearbeitung auf hochmoderne CNC-Technik und erreicht vor allem durch sorgfältige Handarbeit bei der Oberflächenveredelung dieses einmalige Endresultat. MWE-Spitzentechnologie gepaart mit einer vorbildlichen Kundenkommunikation, das ergibt „Qualität aus Leidenschaft“!

A PASSION FOR QUALITY

MWE stands for maximum production quality and a great love of detail. We consider it our philosophy and task to develop products from Germany that consistently correspond with the spirit of the times and also enables room for individuality. This means that all MWE employees always correspond with the highest standards involving design, production quality, and functionality.

In particular: All products are subject to a complex production sequence, about 100% of which takes place on our own premises. MWE utilises highly-modern non-chipping CNC machines, and this unique final result is achieved via careful, hand-crafted surface refinement. Paired with its exemplary customer communication strategy, MWE's leading technology produces 'Quality built on Passion'!

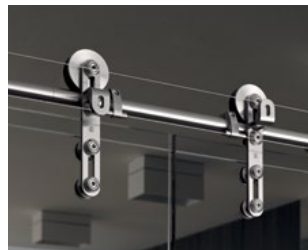

Türsysteme | Door systems



Duschsysteme | Shower systems



Leitersysteme | Ladder systems



- + EINE KLARE ENTSCHEIDUNG FÜR DEN STANDORT DEUTSCHLAND
- + DESIGN UND TECHNIK AUS EINEM HAUS
- + MODERNSTE CNC-TECHNIK
- + ECHE HANDARBEIT FÜR BESTE ERGEBNISSE
- + HAUSEIGENE QUALITÄTSTESTS

- + A CLEAR DECISION REGARDING THE LOCATION GERMANY
- + DESIGN AND TECHNOLOGY FROM A SINGLE PROVIDER
- + THE MOST MODERN CNC TECHNOLOGY
- + GENUINE HAND-CRAFTED WORK FOR IDEAL RESULTS
- + IN-HOUSE QUALITY TESTING



PICO



SPIRIT

SPIRIT AKZENT



AGITUS M

SIRIO



ZARGE



MIAMI

LUNA

CLARO / AQUA

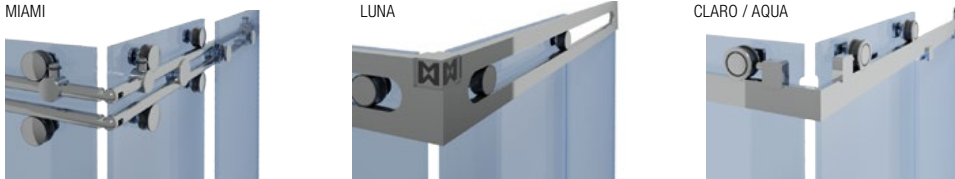

Impressum

Produktedesign: Mario Wille, MWE Edelstahlmanufaktur GmbH
 MWE Edelstahlmanufaktur GmbH, 2014. Alle Rechte vorbehalten.
 Produktdesign, Bilder und Texte sind urheberrechtlich geschützt.
 Jede Verwendung der Bilder, Texte oder von Teilen derselben
 bedarf der ausdrücklichen schriftlichen Genehmigung der
 MWE Edelstahlmanufaktur GmbH.

Credits

Product design: Mario Wille, MWE Edelstahlmanufaktur GmbH
 MWE Edelstahlmanufaktur GmbH, 2014. All rights reserved.
 Product design and texts are protected by European copyright laws.
 Any reproduction or use of these texts or parts thereof requires
 the express written permission of MWE Edelstahlmanufaktur GmbH.

Kurzbeschreibung Symbole
 Description of symbols

Mithilfe der Symbole bekommen Sie eine schnelle Übersicht über die Zusatzfunktionen und Einsatzmöglichkeiten der einzelnen Duschsysteme. The symbols will give you a quick overview of the extra features and application options for each shower system.

Anbringung und Winkel | Anbringung und Winkel

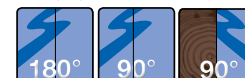

Glas/Glas | Glas 90° | Glas/Wand 90°
 Glass/Glass | Glass 90° | Glass/Wall 90°

Beschlagsart | Beschlagsart

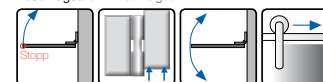

Anschlag | Hebeband | Pendelband | Schiebetür
 Door Stop | Lifting hinge | Swinging hinge | Sliding door

Wand-/Glasbefestigung | Glass/Wall mounting

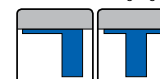

Einseitig | Zweiseitig
 Onesided | Doublesided

Befestigungsoption | Mounting option

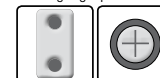

Gegenplatte | Senkpunkthalter
 Counter plate | Countersunk

Türblattstärke | Possible door thickness



Maximales Türblattgewicht | Maximum door weight



Duschsysteme mit Anschlag
 Shower systems with a door stop

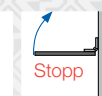

PICO 12

Duschsysteme mit hebendem Türband
 Shower systems with a lifting hinge

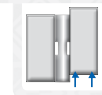

SPIRIT 14
 SPIRIT AKZENT 16

Duschsysteme mit Pendeltüren
 Shower systems with a swinging hinge

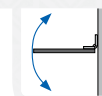

AGITUS M 18
 SIRIO 22

Duschsystem mit Zarge
 Shower systems with a door frame



ZARGE 26

Duschsysteme mit Schiebetüren
 Shower systems with a sliding door

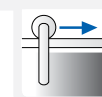





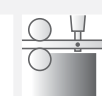

































MIAMI 30
 LUNA 32
 CLARO / AQUA 34

Zubehör | Accessories



Stabilisationsstange 36
 Verbinder 38
 Türknäufe 39

	PICO	SPIRIT	NEU! SPIRIT AKZENT	NEU! AGITUS M	NEU! SIRIO	
Nischenduschen						
						
						
						
						
						
Eckduschen						
						
						

	PICO	SPIRIT	NEU! SPIRIT AKZENT	NEU! AGITUS M	NEU! SIRIO	
Eckduschen						
						
						
						
						
						
						
						
						
						

PICO SPIRIT **NEU!** SPIRIT AKZENT **NEU!** AGITUS M **NEU!** SIRIO

U-Duschen						
Wannen-Duschen						

PICO SPIRIT **NEU!** SPIRIT AKZENT **NEU!** AGITUS M **NEU!** SIRIO

Mannen-Duschen						
Walk-In-Duschen		<p><u>Möglich mit der Stabilisationsstange:</u> Stabilisationsstange mit Glasverbinder (bis 1000 mm) Stabilisationsstange mit Teleskopfunktion und ggf mit Zusätzlichem Glasverbinder für Stabilisationsstangen</p>		<p><u>Possible with Stabilisationbar:</u> Stabilisationbar with glass connector (up to 1000 mm) Stabilisationbar with telescopic function and if applicable with additional glassconnector</p>		
		<p><u>Möglich mit der Stabilisationsstange:</u> Stabilisationsstange mit Glasverbinder (bis 1000 mm) Stabilisationsstange mit Teleskopfunktion und ggf mit Zusätzlichem Glasverbinder für Stabilisationsstangen</p>		<p><u>Possible with Stabilisationbar:</u> Stabilisationbar with glass connector (up to 1000 mm) Stabilisationbar with telescopic function and if applicable with additional glassconnector</p>		
		<p><u>Möglich mit der Stabilisationsstange:</u> Stabilisationsstange mit Glasverbinder (bis 1000 mm) Stabilisationsstange mit Teleskopfunktion und ggf mit Zusätzlichem Glasverbinder für Stabilisationsstangen</p>		<p><u>Possible with Stabilisationbar:</u> Stabilisationbar with glass connector (up to 1000 mm) Stabilisationbar with telescopic function and if applicable with additional glassconnector</p>		
Schlebeduschen						

* Die gezeigte Duschsituation würde nur ein Öffnen nach Innen ermöglichen. Der Beschlag sollte daher außen angebracht werden.
* The shown shower setting only allows an inwards opening. The fixtures should be therefore fitted outwards.



Duschsysteme mit Drehtüren

Shower systems with a pivot door



PICO

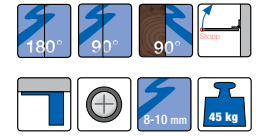

Der Duschtürbeschlag PICO verbindet schlichtes Design mit einer hohen Funktionalität. Die rückseitigen Senkpunkthalter vereinfachen die Reinigung und unterstützen das elegante Erscheinungsbild des Duschtürbandes. Natürlich liefert MWE auch eine Variante für die Glasanbindung.

The PICO shower door fitting combines a simple design with high functionality. The countersunk mounts on the rear make cleaning easier and add to the elegant appearance of the shower door hinge. Of course, MWE also supplies a version of this hinge adapted for a glass connection.



PICO mit Wandbefestigung
PICO with wall fastener

- Glas-Glas-Befestigung 90°
- Glas-Glas-Befestigung 180°
- Wand-Glas-Befestigung 90°
- Anschlagsband
- Einseitige Befestigung
- Senkpunkthalter

- Glass-to-glass fastener (90°)
- Glass-to-glass fastener (180°)
- Wall-to-glass fastener (90°)
- Door stop hinge
- Single-sided fastener
- Countersunk mount



Hebeband SPIRIT mit einer Glas-Glas-Befestigung an der Saunatur
SPIRIT lifting hinge with a glass-to-glass fastener on the sauna door

SPIRIT

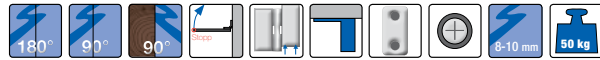

Ein stilvollerer Allrounder ist das selbstschließende Hebeband SPIRIT. Hierauf basierend wurde eine komplette Beschlagsserie von MWE entwickelt, die mit ihrem klaren und gleichzeitig edlen Look in jeder Verbindung einen überzeugenden Eindruck macht. Magnetische Abdeckungen kaschieren dezent die Verschraubungen und sorgen für eine leichte Reinigung der Edelstahlfächen.

The self-closing SPIRIT lifting hinge is a stylish all-rounder based on which MWE has developed an entire series of fittings. Their simple and elegant look will make a positive impression on any type of connection. Magnetic caps discreetly hide the screws and allow the stainless steel surfaces to be cleaned easily.



- Glas-Glas-Befestigung 90°
- Glas-Glas-Befestigung 180°
- Wand-Glas-Befestigung 90°
- Anschlagsband
- Hebeband
- Ein- oder zweiseitige Befestigung
- Senkpunkthalter
- Gegenplatte

- Glass-to-glass fastener (90°)
- Glass-to-glass fastener (180°)
- Wall-to-glass fastener (90°)
- Door stop hinge
- Lifting hinge
- Single or double-sided fastener
- Countersunk mount
- Counter plate



SPIRIT AKZENT

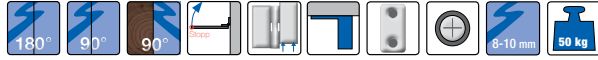

Unser hebendes und selbstschließendes Duschband SPIRIT hat sich durch seine schlichte Eleganz und die ausgereifte Technik einen festen Platz auf dem Markt für Duschbänder erworben. Dennoch ist Stillstand auch im Fall SPIRIT nie eine Option gewesen. Im Zuge der Entwicklung und Konstruktion neuer MWE-Duschbänder wurde auch das Hebeband SPIRIT unter die Lupe genommen und intensiv weiterentwickelt. Aber nicht nur das: Für die Liebhaber der geraden Linie gibt es ab sofort das Hebeband SPIRIT AKZENT. Wie schon sein Vorgänger gibt es dieses Band in sämtlichen Anschluss-Varianten für Glas und Wand.

The simple elegance and advanced technology of the lifting and self-closing SPIRIT shower hinge have firmly secured its place on the shower hinge market. However, we have never been a company to stand still, and that also applies to the SPIRIT fittings. During the development and construction of new MWE shower hinges, the SPIRIT lifting hinge was also examined carefully and enhanced. But that's not all: Fans of straight lines can now also take advantage of the SPIRIT AKZENT lifting hinge. Like its predecessors, this hinge is available in versions for all types of connections, for fixing to glass and walls.



Hebeband SPIRIT AKZENT mit einer Glas-Glas-Befestigung
SPIRIT AKZENT lifting hinge with a glass-to-glass fastener

Auch diese kantige Designvariante SPIRIT AKZENT verfügt über sämtliche technische Details der SPIRIT-Familie. Zudem übererfüllt es auch die DIN für Duschbänder mit mehr als einer halben Million Zyklen (bei geforderten 20.000 Zyklen).

The lifting hinge. This angular-shaped version - SPIRIT AKZENT - boasts all the technical details of the SPIRIT family. It also exceeds the DIN requirements for shower hinges, withstanding over half a million cycles (the requirement is for 20,000 cycles).



AGITUS M

Das sowohl in der Raumentrennung als auch als Duschbeschlag sehr erfolgreiche Pendeltürband AGITUS L wurde speziell für die Dusche angepasst: Das Pendelband AGITUS M ist die kleinere Variation dessen und mit seinem besonders geringen Schließwinkel speziell für begrenzte Badsituationen geeignet. Alle Befestigungen des aus Vollmaterial gefertigten Beschlages liegen hinter flächenbündigen Magnetabdeckungen.

So auch die Einstellschrauben für die Nullstellung, die hier ganz einfach von einer Seite eingestellt werden kann. Ein ständiger Seitenwechsel beim Justieren ist somit nicht nötig. Auch AGITUS M steht für modernste Herstellungstechnik und filigranes Design, das von Hand veredelt wird – wahlweise mit einer seidig geschliffenen (Korn 600/ Schmuckschliff) oder hochglanzpolierten Oberfläche.

- Glas-Glas-Befestigung 90°
- Glas-Glas-Befestigung 180°
- Wand-Glas-Befestigung 90°
- Pendelband
- Ein- oder zweiseitige Befestigung
- Gegenplatte



AGITUS M mit einer Wand-Glas-Befestigung
AGITUS M with a wall-to-glass fastener



AGITUS M

- Glass-to-glass fastener (90°)
- Glass-to-glass fastener (180°)
- Wall-to-glass fastener (90°)
- Swinging hinge
- Single- or doublesided fastener
- Counterplate

The AGITUS L swinging door hinge, which has been extremely successful in room partitions and as a shower fitting, has been specially adapted for showers: The AGITUS M swinging hinge is a smaller modified version of the AGITUS L and, thanks to its particularly small closing angle, is ideal for narrow bathrooms. All fasteners for the solid metal shower door fitting are hidden behind flush magnetic caps.

The same applies to the adjusting screws for the neutral position, which can also quite easily be adjusted from one side. This means that it is not necessary to constantly change sides while adjusting them.

The AGITUS M also represents state-of-the-art manufacturing technology and a sophisticated design which is finished by hand – you can choose from a glossy (600 grit/decorative polish) or a highly polished surface.

AGITUS L

Das Pendeltürband AGITUS M ist auch in einer größeren Variante erhältlich: AGITUS L
Mehr dazu in unserer Broschüre der Türsysteme oder online unter www.mwe.de

Door hinge AGITUS M is available in a bigger version as well: AGITUS L.
Please read more about it in our door systems brochure or online: www.mwe.de





SIRIO mit einer Glas-Glas-Befestigung
SIRIO with a glass-to-glass fastener

SIRIO



Die feinst verarbeiteten Edelstahlriegel des massiven Bandes verstecken sämtliche Verschraubungen unter magnetischen, fast unsichtbaren Deckeln. Die Nullstellung des SIRIO-Pendelbandes lässt sich wie beim SPIRIT stufenlos einstellen. Bei einem Öffnungswinkel von ca. 20° schließt sich die Tür selbstständig.

- Glas-Glas-Befestigung 90°
- Glas-Glas-Befestigung 180°
- Wand-Glas-Befestigung 90°
- Pendelband
- Einseitige Befestigung
- Gegenplatte



SIRIO



The finely finished stainless steel rail of the very large hinge hides all the screws under magnetic caps which are practically invisible. The neutral position of the SIRIO swinging hinge can be adjusted in small increments just like the Spirit hinge. With an opening angle of approximately 20°, the door is self-closing.

- Glass-to-glass fastener (90°)
- Glass-to-glass fastener (180°)
- Wall-to-glass fastener (90°)
- Swinging hinge
- Single sided fastener
- Counterplate



SIRIO mit einer Wand-Glas-Befestigung
SIRIO with a wall-to-glass fastener



EDELSTAHLZARGE



Duschkabinen in markantem Rahmen. Der Eingang der U-förmigen Duschkabinen wird eingerahmt durch die massiven, »Akzent-typischen« Edelstahlzargen. Am Boden schließen die Festteile mit einem sehr feinen Edelstahlprofil ab. Durch die umlaufenden Dichtelemente im Zusammenspiel mit dem massiven Rahmen wird der Wasseraustritt minimiert. Für die MWE-Edelstahlzarge gibt es aufgrund des vielfältigen Zubehörs abwechslungsreiche Einsatzmöglichkeiten.

Shower enclosures with distinctive frames. The door to the U-shaped shower enclosures is a solid stainless steel frame typical of the Akzent system. The fixed elements are sealed to the floor by a very thin stainless steel section. The combination of the frame and the allround sealing elements for the door leaf ensure a high degree of water-tightness for the two shower units. Application possibilities for this MWE stainless steel frame are multifaceted with various accessories.



Schlosskasten Akzent R Studio inkl. Drückerpaar
Akzent R Studio door opener incl.



Türband Akzent R
Akzent R door hinge



Seitenverbinder
Edge connector



Glas-Glas-Eckverbinder
Glass-to-Glass corner connector



Glas-Wandverbinder
Glass-to-Wall connector



Duschsysteme mit Schiebetüren

Shower systems with sliding doors



MIAMI

Dieses Duschsystem zeichnet sich durch seine hohe Stabilität und eine maximale Montagefreundlichkeit aus. Konzeptioniert wurde MIAMI für Nischenduschen und für Einbausituationen, bei denen eine möglichst breite Duschtür zum Einsatz kommen soll. Ein einfaches Kürzen der Laufrohre ist bei Maßtoleranzen vor Ort somit schnell möglich. Die Standardoberfläche ist geschliffen in Korn 600 (Schmuckqualität), auf Wunsch ist das Duschsystem auch in teilpoliert oder komplett hochglanzpoliert lieferbar.

This impressive shower system is extremely stable and very easy to install. The MIAMI system has been designed for recessed shower enclosures and for installation situations where the shower door needs to be as wide as possible. The rail can be quickly and easily shortened to fit the maximum tolerances or if bearing sets are used. The standard surface is made from brushed 600 grit (decorative quality) and there is also an option for the shower system to be supplied with a partially polished or highly polished finish throughout.

Kürzbare Laufrohre

Glasstärke: 8–10 mm

Geeignet für Eckduschen

Geeignet für Nischenduschen

Geeignet für U-Duschen

Length-adjustable rail

Glass thickness: 8-10 mm

Suitable for corner shower enclosures

Suitable for recessed shower enclosures

Suitable for U-shaped shower enclosures



Duschsystem MIAMI
MIAMI shower system



Zum Montagevideo
Deutsch



To installation video
in English



LUNA

Unaufdringlich, klar und mit kühler Eleganz besticht die schlanke Linienführung des Duschsystems LUNA. Durch den herausnehmbaren Türstopper lassen sich die Türen ohne Glasüberstand öffnen und somit reinigen. Die präzisen Ausfräsungen lassen die Dusche LUNA weniger wuchtig erscheinen und gewähren den Blick auf die handverarbeiteten Rollen.

The impressively unostentatious and simple LUNA shower system has a cool elegance. A precise milled edge guarantees a view of the hand-finished rollers with a less massive appearance. The removable door stoppers mean that the doors can be opened, and therefore cleaned, without the glass overlapping.



Glasstärke: 10 mm
Geeignet für Eckduschen
Geeignet für Nischenduschen
Geeignet für U-Duschen

Glass thickness: 10 mm
Suitable for corner shower enclosures
Suitable for recessed shower enclosures
Suitable for U-shaped shower enclosures

Duschsystem LUNA
LUNA shower system



CLARO / AQUA



Mit einem Maximum an Funktionalität ist das Duschsystem CLARO ein Minimalist unter den Duschen aus dem Hause MWE. Neben dem sehr kleinen Spaltmaß und den leicht laufenden Rollen ist auch hier der Türblattstopper so konzipiert, dass die komplette Glasfläche gereinigt werden kann. Während der Planung kann man durch den Austausch ausgewählter Artikel andere optische Akzente setzen:
Dusche AQUA oder CLARO.

Featuring outstanding functionality, the CLARO shower system boasts MWE's minimalist design. In addition to its small dimensions and easy-running rollers, the door panel stopper is designed so that the entire surface of the glass can be cleaned. Visual accents can be setted bay interchanging some items during planning phase.
AQUA or CLARO

- Glasstärke: 10 mm
- Geeignet für Eckduschen
- Geeignet für Nischenduschen
- Geeignet für U-Duschen

- Glass thickness: 10 mm
- Suitable for corner shower enclosures
- Suitable for recessed shower enclosures
- Suitable for U-shaped shower enclosures





STABILISATIONSSTANGE TELESCOPIC SUPPORT BAR

Bei der Konstruktion und Entwicklung der neuen Stabilisationsstange DU.3355 war uns ein filigranes Design des Produkts (Außenmaß Stange: 18 x 18 mm) mit einem Höchstmaß an Flexibilität wichtig, das zudem – aufgrund der MWE-typischen Fertigung aus Vollmaterial – durch besondere Stabilität überzeugt. Der Festteilhalter ist an beiden Enden mit einer Teleskopfunktion ausgestattet, deren Befestigung durch eine magnetische Abdeckung verdeckt wird. Darüber hinaus sind sämtliche Befestigungspunkte im Winkel verstellbar und zudem waagrecht oder senkrecht montierbar.

We have been dealing intensively with technical requirements and considering many ideas of our customers to develop the new support bar DU.3355. The result is a solid slim product of high flexibility (outer dimensions of the bar are 18 x 18 mm). Fabrication of solid material, that is typical for MWE, makes the bar perfectly stable. The support bar features telescopic functions on both ends whose screwing is concealed by a magnetic cap. Furthermore all clamping mechanisms are rotatable and can be fixed in horizontal and vertical positions. It may be especially useful for wall mounting in pitched roof areas.

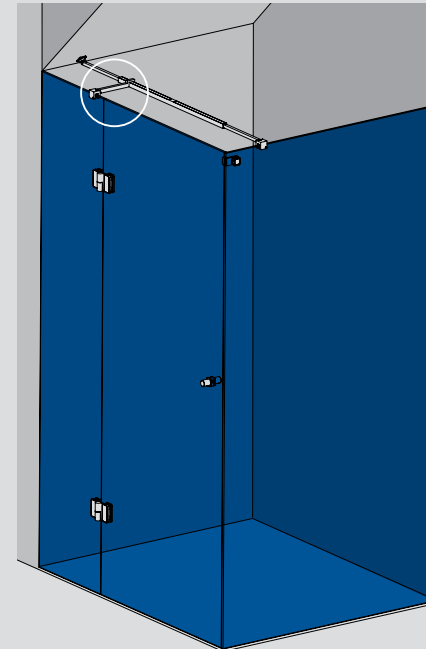
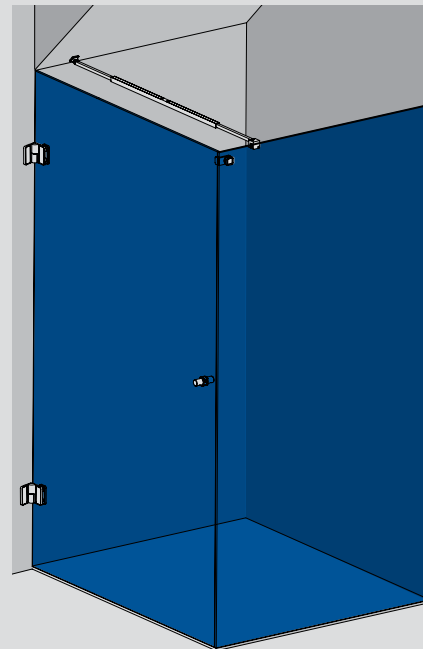

ZUSATZ-GLASVERBINDER ADDITIONAL GLASS CONNECTOR

Passend zur Stabilisationsstange Akzent DU.3355 haben wir einen zusätzlichen Glashalter entwickelt, der weitere Glasfestteile fixiert. Ebenfalls mit einem Schwenkopf ausgestattet, lässt sich dieser Glashalter beliebig auf der Stabilisationsstange platzieren.

An additional glass connector perfectly matches the support bar Akzent DU.3355. The connector is provided by MWE to stabilize additional fixed glass panels. It comes with a rotatable glass mount and can be placed arbitrarily on any position of the support bar.



Zusatzhalter wird mit einem Gewindestift befestigt.
Additional connector can be fixed via a headless screw.



VERBINDER CONNECTOR

Glas-Glas-Eckverbinder DU.3304.V



Winkelverstellbar, 70°-180°
Verdeckte Verschraubungen
Senkpunkthalter
Für alle Duschsysteme passend

Adjustable angle, 70°-180°
Hidden screws
Countersunk fastener or counterplate
Suitable for all shower systems

Seitenverbinder DU.3302 und Anschlag DU.3305



180°, verdeckte Verschraubungen
Senkpunkthalter oder Gegenplatte
Für alle Duschsysteme passend

180°, hidden screws
Countersunk fastener or counterplate
Suitable for all shower systems

Wand-Glas-Eckverbinder DU.3301 und Anschlag DU.3306



90°, verdeckte Verschraubungen
Senkpunkthalter oder Gegenplatte
Für alle Duschsysteme passend

90°, hidden screws
Countersunk mount or counterplate
Suitable for all shower systems

Glas-Glas-Eckverbinder ST.7004.V



Winkelverstellbar, 85°-180°
Verdeckte Verschraubungen
Senkpunkthalter oder Gegenplatte
Für alle Duschsysteme passend

Adjustable angle, 70°-180°
Hidden screws
Countersunk mount or counterplate
Suitable for all shower systems

Glas-Boden-Deckenhalter ST.7001.V



Mit Höhenverstellung
Senkpunkthalter oder Gegenplatte
Für alle Duschsysteme passend

Height-adjustable
Countersunk mount or counterplate
Suitable for all shower systems

Glas/Glas-Eck-Seitenverbinder ST.7004.AR



Winkelverstellbar, 85°-180°
Verdeckte Verschraubungen
Senkpunkthalter oder Gegenplatte
Für alle Duschsysteme passend

Adjustable angle, 70°-180°
Hidden screws
Countersunk mount or counterplate
Suitable for all shower systems

Glas-Boden-Deckenhalter ST.7001.AR



Mit Höhenverstellung
Senkpunkthalter oder Gegenplatte
Für alle Duschsysteme passend

Height-adjustable
Countersunk mount or counterplate
Suitable for all shower systems

Glas-Glas-Eckverbinder DU.3324.V



Winkelverstellbar, 70°-180°
Verdeckte Verschraubungen
Senkpunkthalter oder Gegenplatte
Für: AGITUS M, SPIRIT und SPIRIT AKZENT

Adjustable angle, 70°-180°
Hidden screws
Countersunk mount or counterplate
For: Agitus M, Spirit and Spirit Akzent

NEU!

Seitenverbinder DU.3321



90°, verdeckte Verschraubungen
Senkpunkthalter oder Gegenplatte
Für: AGITUS M, SPIRIT und SPIRIT AKZENT

180°, hidden screws
Countersunk mount or counterplate
For: Agitus M, Spirit and Spirit Akzent

NEU!

STOPPER UND GRIFFE STOPPER AND HANDLES

Stopper PT.7110.AN



Bodenanschlag für Pendeltüren

Floor stop for swinging doors

Stopper ST.3150.UV

Türblattstopper
Zur UV-Verklebung geeignetDoor panel stopper
Suitable for UV bonding

Türknaufpaar SA.3300/3310

Türknaufpaar Ø 25 mm
Türknaufpaar Ø 40 mmDoor knob pair, 25 mm diameter
Door knob pair, 40 mm diameter

Türknaufpaar SA.3315.25



Türknaufpaar eckig Ø 25 mm

Door knob pair, 25 mm diameter
Door knob pair, 40 mm diameter

Griffmuscheln: GR.5908/GR.3226

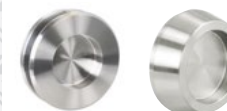

Griffmuschel für Glas 8-12 mm

Flush pull for glass, 8-12 mm



Fachhändler-Distributor:

www.mwe.de